

IZOMETRICKÝ POHLED

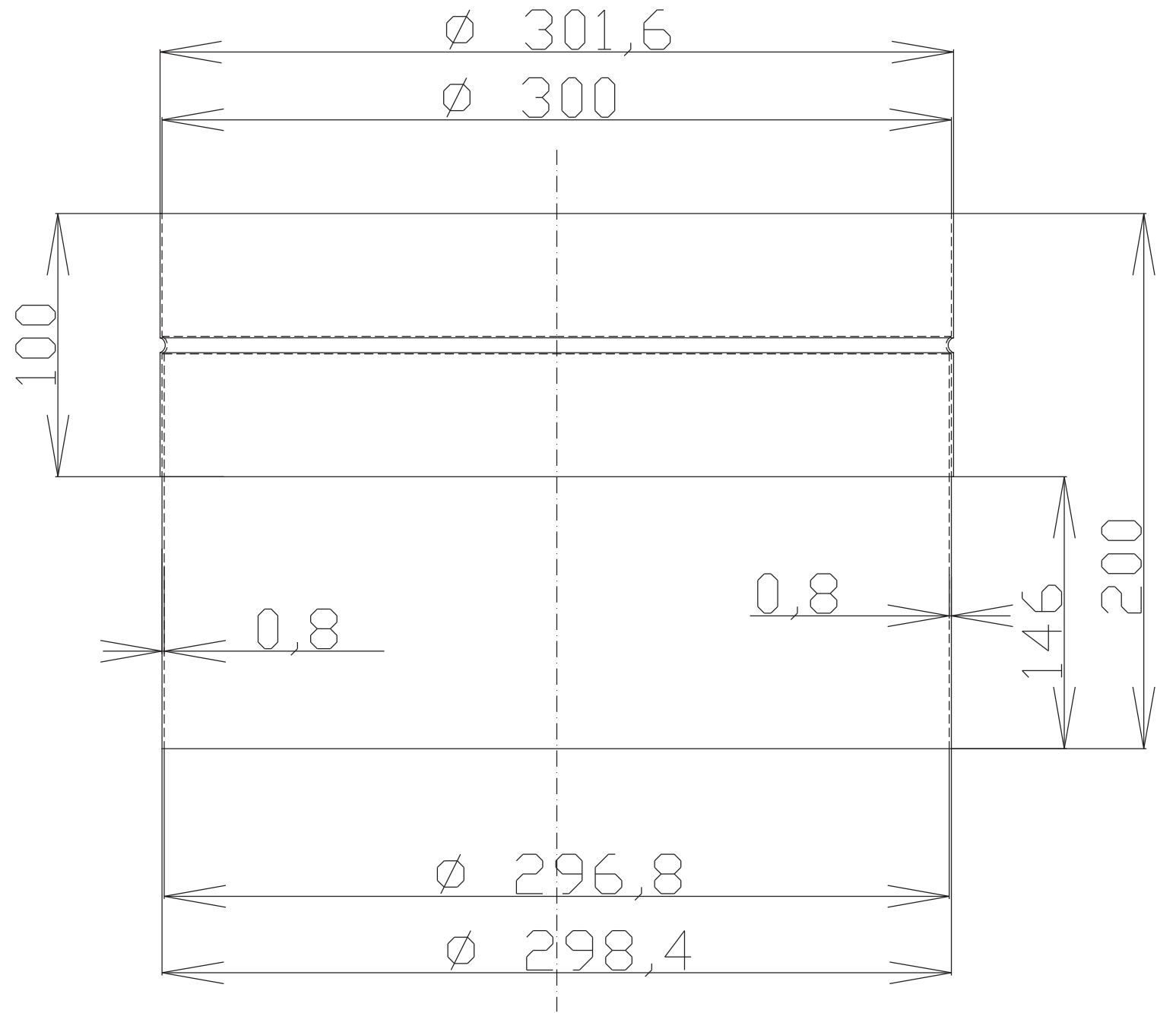
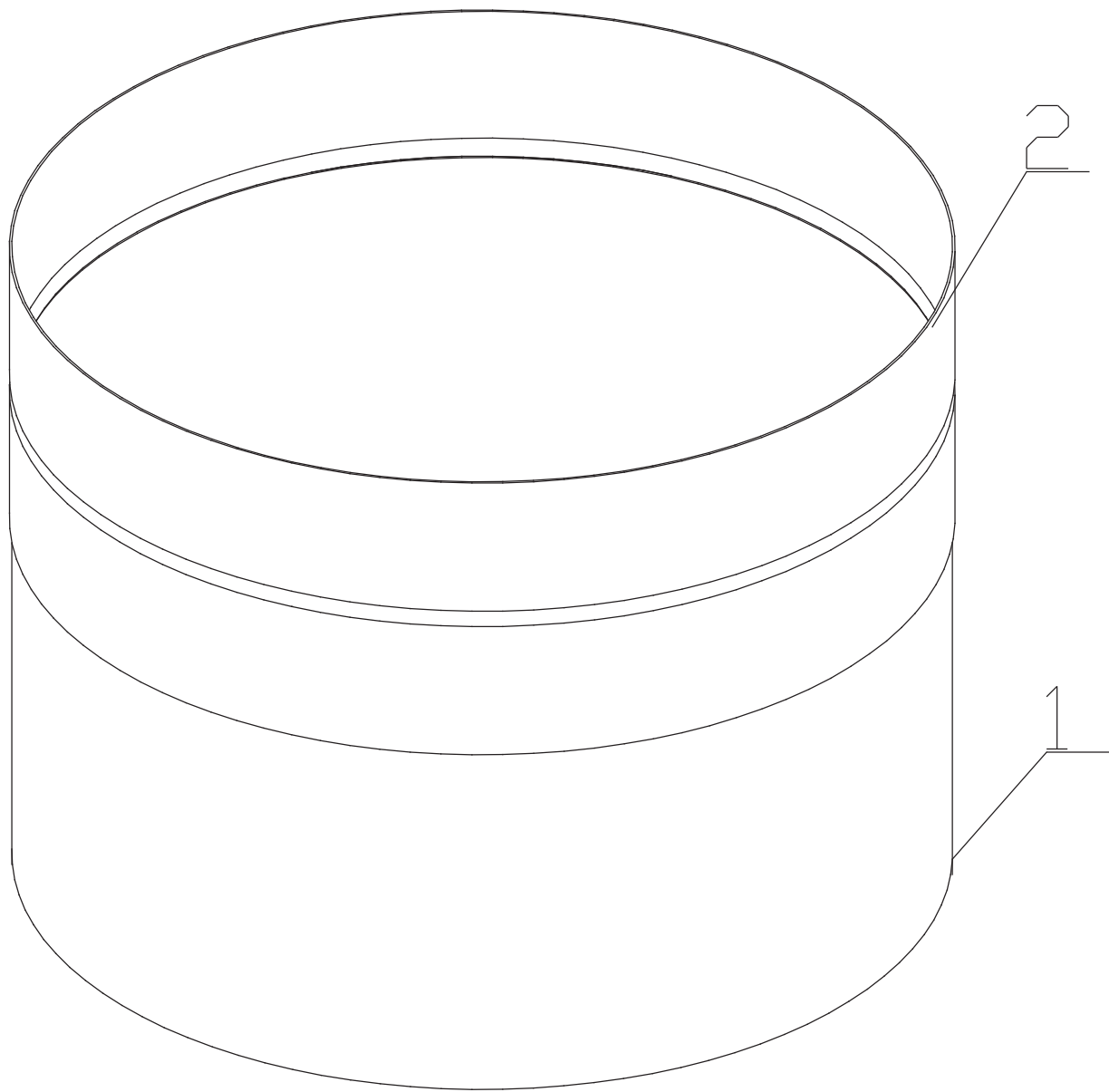

STAVITELNÝ DÍL 200 STL-024